

L3evo

POWERFUL, PROFESSIONAL AND EASY TO USE

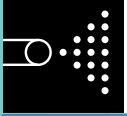

**NOT
AVAILABLE
IN
EUROPE**

L3evo is the evolution of our famous L3, a dedicated machine to professionals who guarantee long life and work capacity. The mist sprayer allows for low volume treatments. The uniform size of the drops dispensed, combined with the action of air which moves the leaves, allows effective and uniform protection on both sides of the treated surface.

 **CIFARELLI** The fruits of the Earth in good hands. Since 1967.

	L3Evo	
Engine	Model C7 / 2-stroke / 77 cc / 3,6 kW	
Air speed	125 m/s	
Air volume	20 m ³ /min	
Dry weight (Mod. L3E)	Without tubes 10,13 Kg	With tubes 11,36 Kg
Fuel tank capacity	1,9 L	2,3 L (Mod. L3VOW only)
Drops micronization	Ø 120 µm	
Liquids outflow	0-3,6 L/min	
Maximum range	Horizontal: 17 m	Vertical: 15 m
Packaging	49 x 74 x 38 cm	

At the time of spraying, every cultura and every plant needs the right amount of liquids. Because of that this machine is available in different models, each designed to have features and performance specific but all always handy and light.

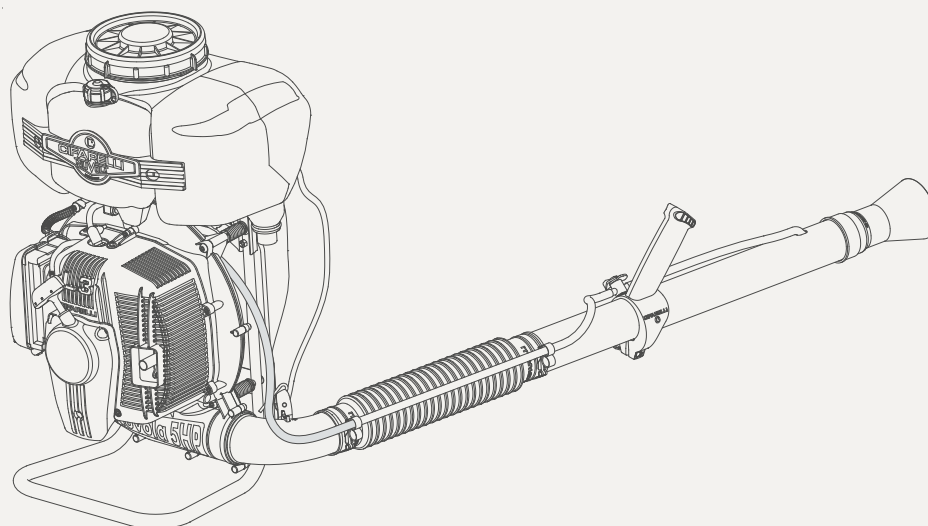

EASY
TO USE

POWERFUL

EFFICIENT

RELIABLE

MADE IN ITALY

Accessories

Our goal is to continually improve. And another quality of our machines is their versatility and adaptability to the work needs of each operator. For this reason, many accessories are available in various models that expand and refine the functions provided.

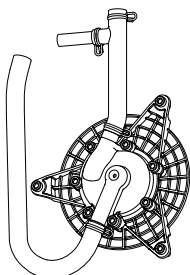
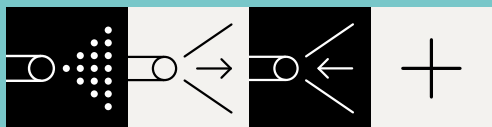

OG.425.00
BOOSTER PUMP

It keeps the solution inside the liquid tank always mixed, it increases and stabilizes the product outlet pressure.

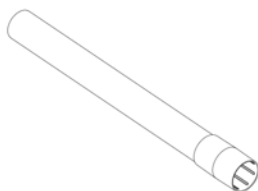

24.019.00
EXTENSION TUBE

It is suitable for particularly aired areas. It allows getting close to the area to treat, while reducing the product dispersion (the booster pump is necessary).

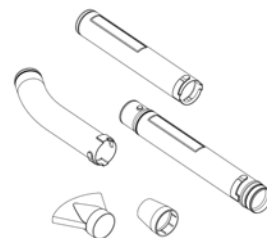

OG.095.00
KIT FOR BLOWING
Pipes and diffusers for blowing.

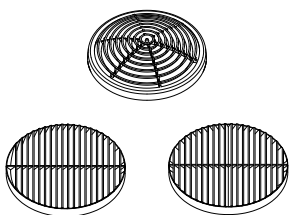

OG.341.00
KIT 3 DIVERTERS

It includes the 45° grid for diverting the product outflow, the round grid for decreasing the speed of the outcoming air, for greenhouse treatments and the double-angle grid for separating the flow in two ways.

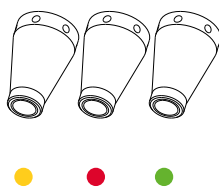

OG.150.00
KIT 3 CALIBRATED NOZZLES

Three nozzles of different colors with calibrated pad Ø 1.5 - Ø 2.5 - Ø 4.0. Calibrate the amount of product output (recommended to use with the booster pump).



OG.104.00
ULV DIFFUSER

It doses the amount of the outcoming product and allows performing ultra low volume treatments to obtain drops Ø less than 70 µm (the booster pump is recommended).

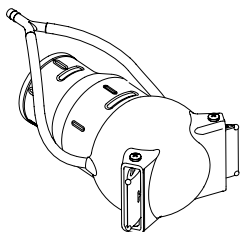

OG.274.00
SPHERICAL DIVERTER

It allows to direct the liquid at the same time in two rows.

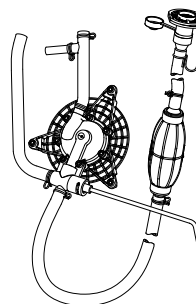

OG.426.00
BOOSTER AND FILLING PUMP

It keeps the solution inside the liquid tank always mixed, it increases and stabilizes the product outlet pressure. It allows filling up the tank without having to take the equipment off your shoulders.